



## CONDENSER COILS RADIATOR MOUNTED MULTI-FLOW



DESCRIPTION	HEIGHT	OVERALL WIDTH	DTAC NO.
#6 & #8 Male O-Ring fittings same end - 14 FINS per inch	12	18	07-01218
#6 & #8 Male O-Ring fittings same end - 14 FINS per inch	14	21 3/4	07-01437
#6 & #8 Male O-Ring fittings same end - 12 FINS per inch	14	27	07-01439
#6 & #8 Male O-Ring fittings same end - 14 FINS per inch	19 1/2	28 1/2	07-01466
#6 & #8 Male O-Ring fittings same end - 12 FINS per inch	12	27	07-01490

## MULTI-FLOW



DESCRIPTION	HEIGHT	OVERALL WIDTH	DTAC NO.
#6 & #8 Male O-Ring fittings opposite end - 14 FINS per inch	14	28	07-01473

## CONDENSER MOUNTING BRACKETS

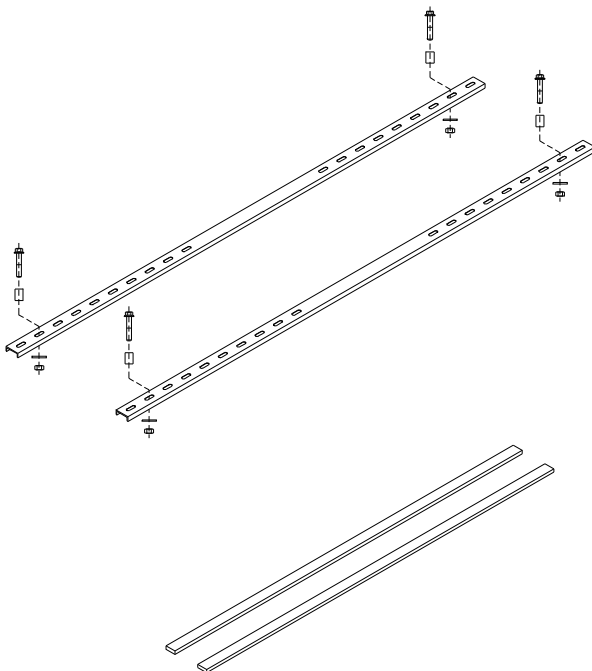

DESCRIPTION	DTAC NO.
Condenser Mounting Bracket used for Multi-Flow and Parallel-Flow 44" Long 1" Wide	07-1042KIT
Condenser Mounting Bracket 1/4" Steel /Flat Stock, No Holes 59" Long 1" Wide	07-01051

# CONDENSER COILS LOW PROFILE FAN MOUNTING BRACKETS



DESCRIPTION	DTAC NO.
Low Profile Fan Bracket*	<b>81-80008</b>



\*Shown with 07-01439 Condenser and 02-4011B-12/24 Sold Separately

## ROOFTOP/REMOTE

APPLICATION	OEM NO.	FITTING TYPE	DTAC NO.
DTAC REMOTE MOUNT	07-34001-12/24 07-34002-12/24	O-RING	<b>07-00341</b>
DTAC REMOTE MOUNT	07-34008-12/24	O-RING	<b>07-01438</b>
DTAC REMOTE MOUNT	07-34010-12/24	O-RING	<b>07-01490</b>
DTAC REMOTE MOUNT	07-35003-12/24	O-RING	<b>07-35003</b>
DTAC REMOTE MOUNT	07-35002-12/24 07-36001-12/24 07-36002-12/24	O-RING O-RING O-RING	<b>07-35001</b>
DTAC REMOTE MOUNT	07-36005-12/24	O-RING	<b>07-36005</b>
DTAC REMOTE MOUNT	07-78000-12/24	O-RING	<b>07-78001</b>
RED DOT R-9727	RD-4-3586-0 77R0350	O-RING	<b>07-37004</b>
RED DOT R-6000, R-6060	RD-4-3874-1 77R0500	O-RING	<b>07-37005</b>
RED DOT R-9730	RD-4-3646-0 77R0800	O-RING	<b>07-37011</b>
RED DOT R-9720-1,2,3,4,5	77R0110	O-RING	<b>07-37014</b>



# CONDENSER COILS EVAPORATOR COILS HEATER COILS DTAC COILS

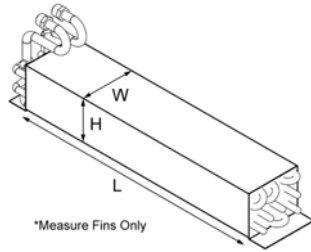

DESCRIPTION FIN & OVERALL DIMENSIONS	FITS DTAC UNIT	DTAC NO.
Heater Core Fin 21.5"L x 3"W x 5"H	217	07-00034
Evaporator Coil Fin 13.25"L x 3.5"W x 6"H	141	07-00141
Heater Core Fin 6.5"L x 1.88"W x 6"H	210	07-00210
Heater Core Fin 12.5"L x 2.5"W x 4"H	212	07-00212
Heater Core Fin 13.75"L x 2"W x 6"H	215	07-00215
Heater Core Fin 5.88"L x 3.75"W x 5"H	218	07-00218
Heater Core Fin 12.5"L x 1.88"W x 5"H	230	07-00230
Heater Coil Fin 6.6"L x 6"W x 3.8"H	232	07-00232
Evaporator Coil Fin 18.5"L x 4" W x 3.18"H	300	07-00300

# CONDENSER COILS EVAPORATOR COILS HEATER COILS DTAC COILS

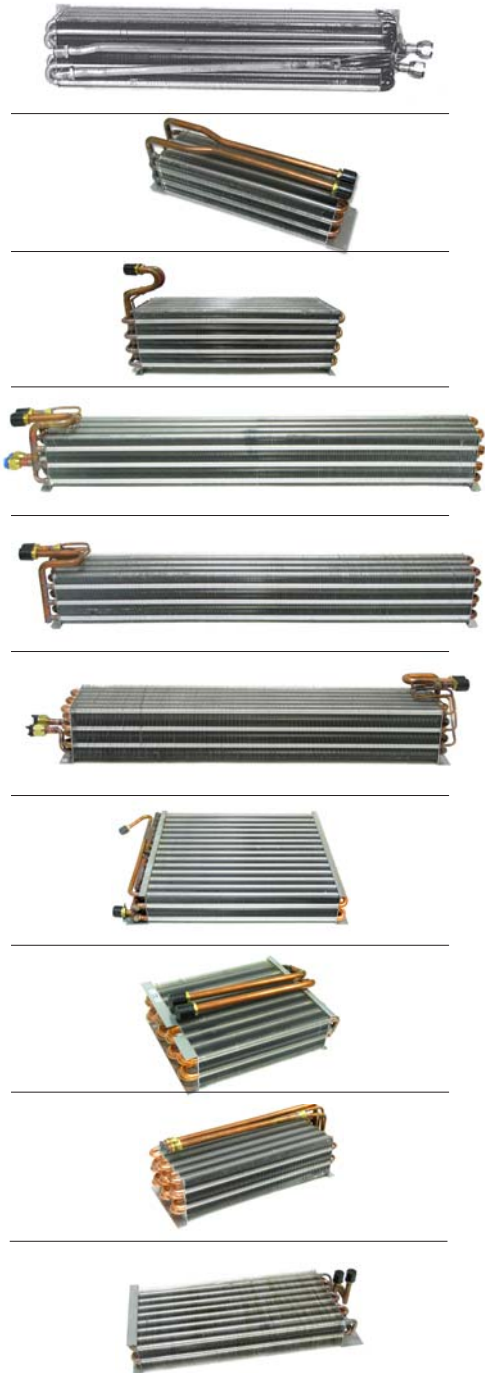
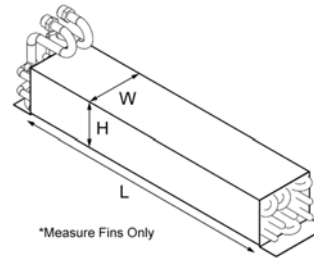

DESCRIPTION FIN & OVERALL DIMENSIONS	FITS DTAC UNIT	DTAC NO.
Heat/Evaporator Coil Fin 18.5"L x 4"W x 4"H	301, 430	07-00301
Evaporator Coil Fin 12.88"L x 4"W x 3"H	305	07-00305
Evaporator Coil Fin 16"L x 6"W x 5"H	310, 311	07-00311
Evaporator Coil Fin 29.125"L x 4"W x 4"H	315 Heat/Cool	07-00315
Evaporator Coil Fin 29.125"L x 4"W x 4"H	315 Cool Only	07-00316
Heat/Evaporator Coil	330, 331	07-00330
Condenser Coil Fin 14.3125"L x 14"W x 2.5"H	07-34001, 07-34002 07-34003-0	07-00342
Evaporator Coil Fin 9"L x 8"W x 2.5"H	500	07-00500
Evaporator Coil Fin 13.25"L x 6"W x 3.25"H	502	07-00502
Evaporator Coil Fin 16"L x 8"W x 2.5"H	701	07-00700



# CONDENSER COILS EVAPORATOR COILS HEATER COILS DTAC COILS

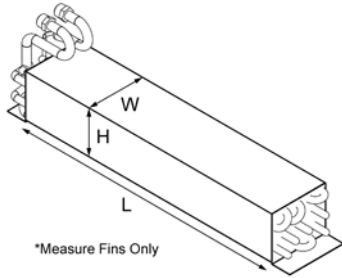

DESCRIPTION FIN & OVERALL DIMENSIONS	FITS DTAC UNIT	DTAC NO.
Condenser Coil Fin 19.5"L x 1.2"W x 1.88"H	701	07-00701
Heat/Evaporator Coil Fin 16"L x 8"W x 5"H	702	07-00702
Heat/Evaporator Coil Fin 14.25"L x 6"W x 4.5"H	402-12BRT 402, 403, 800, 901	07-00912  07-00913
Evaporator Coil Fin 8"L x 3.5"W x 11.5"H	Kobelco Drop-In	07-01550
Evaporator Coil	Komatsu Drop-In	07-01600
Evaporator Coil Fin 14.5"L x 3.25"W x 8"H	Cat Excavator 322, 325, 330 Drop-In	07-01690
Evaporator Coil Fin 11"L x 2.5"W x 12"H	Cat Haul Truck Drop-In	07-07550
Condenser Coil Fin 22.5"L x 9"W x 2.75"H	07-35002, 07-36001, 07-36002	07-35001

**CONDENSER COILS  
EVAPORATOR COILS  
HEATER COILS  
DTAC COILS**

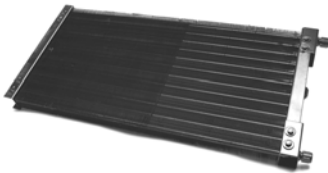
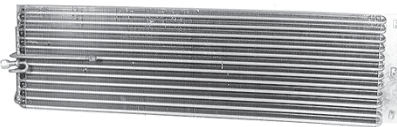
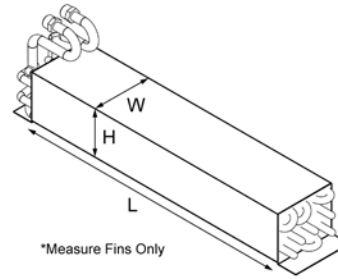

DESCRIPTION FIN & OVERALL DIMENSIONS	FITS DTAC UNIT	DTAC NO.
Condenser Coil Fin 20.5"L x 1.75"W x 8"H	07-35003	<b>07-35003</b>
Condenser Coil Fin 25.87"L x 9"W x 4.375"H	07-36005	<b>07-36005</b>
Condenser Coil Fin 40"L x 12"W x 3.25"H	07-78000-12	<b>07-78001</b>
Condenser Coil Fin 25" Lx 12"W x 1.25"H Fittings Top & Bottom Same End Rifle Tubed 12 Fins per Inch		<b>07-00650</b>

NOTES \_\_\_\_\_  
 \_\_\_\_\_  
 \_\_\_\_\_  
 \_\_\_\_\_  
 \_\_\_\_\_  
 \_\_\_\_\_  
 \_\_\_\_\_