

300 Series Headliner Mount Evaporator

The 300 series is our most popular headliner unit because of its small size and great performance. We offer a variety of external filter and pressurization options as well as a heat\cool model.

BTU's

18,500 (305 Model)
20,200 Cool (300 & 301 Model)
16,600 Heat (301 Model)

Air Flow

295 CFM

Motor

12V - 13 AMPS @ 13.5 VDC
24V - 8 AMPS @ 27 VDC

Features

Available 12 or 24 Volt
Left or Right Side Fitting Location
Adjustable Thermostat
Three Speed Blower Motor
Low Profile for Maximum Head Room
Optional Heat (301 Only)
E-Z Servicing in Mind:
Hinged Lid for Easy Access to All Internal
Without Removing Unit
Durable and Rugged Design:
All Steel Case with Black Powder Coat Finish

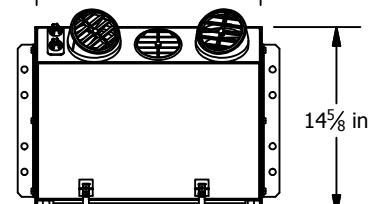
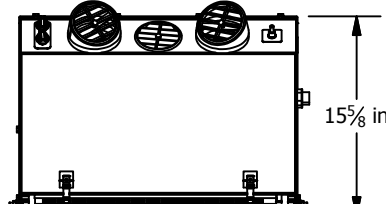
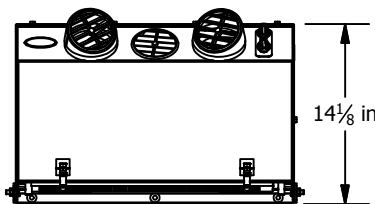
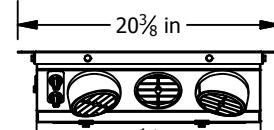
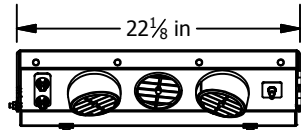
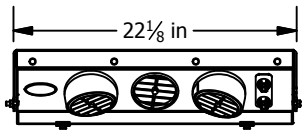
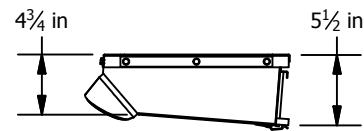
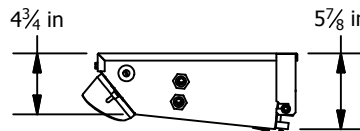
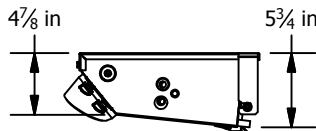
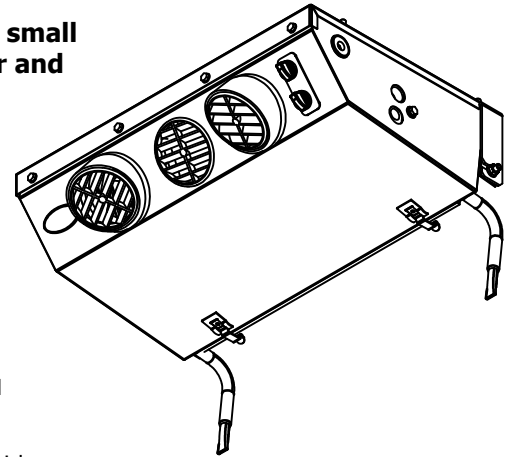

300 Model

301 Model

305 Model

Models	
Part No.	Notes
300-12 or 300-24	Cool Only
301-12 or 301-24	Cool and Heat
305-12 or 305-24	Slim version of 300. Excellent option when space is limited.

*When ordering specify 12 or 24 volt.

Options

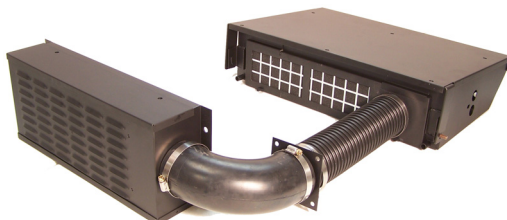

11-52105 External filter kit for 300 and 301.



Donaldson filter kit for 300 and 301.

DTAC Recommends

10-00058, 5/8" heater hose (not included in 301 Heat/Cool model)
30-50253, replacement filter (300,301)
90-10009, replacement filter (305)