

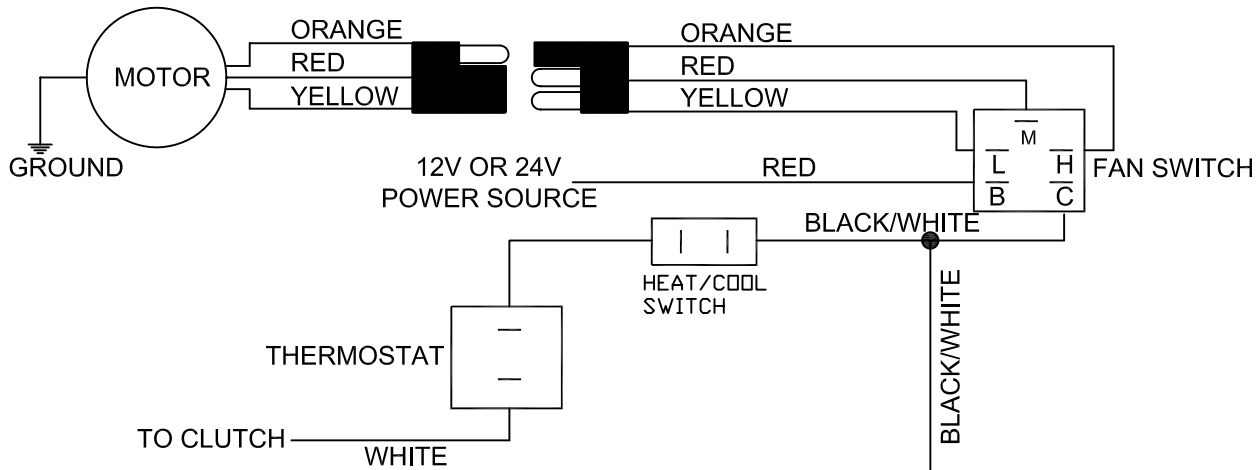

430-12/24, Evaporator Wiring Schematic



NOTE: Use only to actuate relay when using remote power condensor (NOT A GROUND).